



mesoskinline®

MESO POWER DEVICE MS-3



OPERATING MANUAL



PRODUCT OVERVIEW

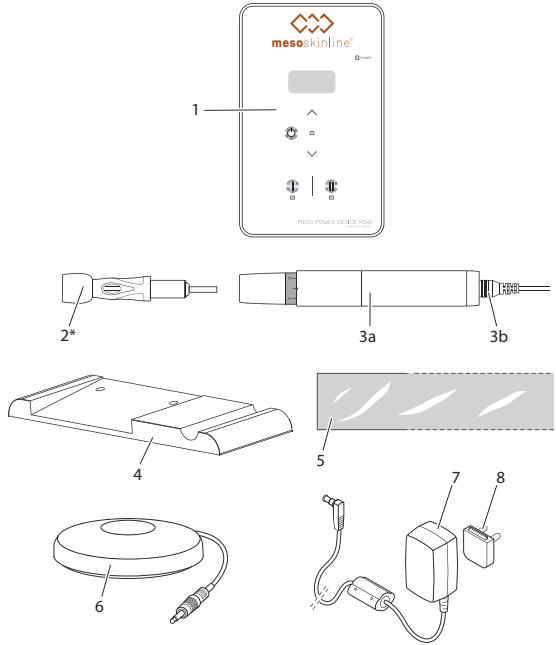

	ARTICLE DESIGNATION	ARTICLE DESCRIPTION
1	Controller	MAD12901
2*	Needle cartridges	"4.3 Accessories and spare parts" on page 16
3a	Handpiece	CMN50
3b	Handpiece cable	5E-G765
4	Handpiece tray	FG-AD1.0-1
5*	Handpiece cover	E-0610
6	Foot switch	E-1010
7	Power supply	E1165
8	Country-specific adapter	EU: E-1154

* Not included with the delivery

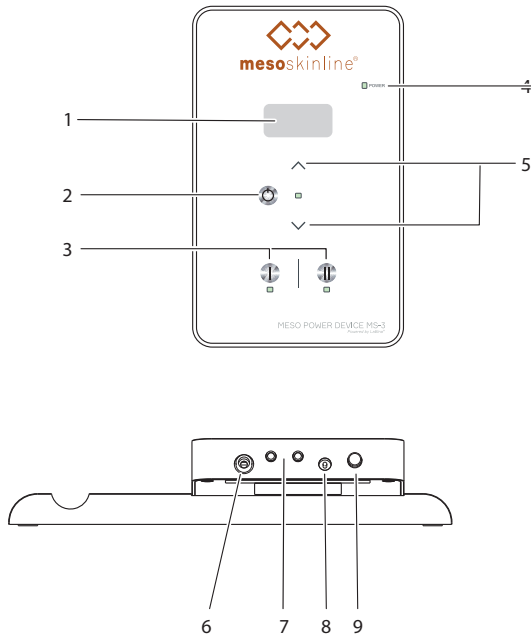

BUTTONS AND CONNECTIONS

- | | |
|---|---|
| 1 | Display |
| 2 | Treatment ON/OFF button (white LED) |
| 3 | Select handpiece I/II buttons (white LED) |
| 4 | Power LED indicator (⦿) (white LED) |
| 5 | Increase frequency (^) button / decrease frequency (v) button |
| 6 | Connection for foot switch |
| 7 | Connection for handpiece I and II |
| 8 | Connection for power supply |
| 9 | Device ON/OFF button |

CONTENTS

1	About this manual.....	6
1.1	Presentation of warning symbols.....	6
2	Important safety instructions	7
2.1	General safety instructions	7
2.2	Product-specific safety instructions	8
2.3	Important health and safety precautions	8
2.4	Contraindications and side effects	10
2.5	Required qualification (user requirements).....	11
2.6	Intended purpose, scope of application and proper use.....	12
2.7	Symbols on the product.....	13
3	Scope of delivery	15
4	Product information.....	16
4.1	Technical data.....	16
4.2	Operating conditions	16
4.3	Accessories and spare parts.....	16
5	Getting started.....	17
5.1	Positioning the device	18
5.2	Connecting the power supply	19
5.3	Connecting the foot switch (optional).....	20
5.4	Connecting the handpiece	21
5.5	Cleaning and disinfecting the equipment.....	21
5.6	Inserting or replacing the needle cartridge.....	22
5.7	Pulling the handpiece cover on	23
5.8	Checking equipment.....	24
6	Use.....	24
6.1	Switching the control unit to operating mode or standby mode.....	24
6.2	Setting the needle protrusion depth.....	25
6.3	Setting the penetration frequency.....	25
6.4	Switching the handpiece on and off.....	26

English
Version 1.0 – 01/2019

Translation of the original operating manual. The original operating manual was generated in German.

7 Cleaning and maintenance 27
7.1 Inspection 27
7.2 Material compatibilities 27
7.3 Disinfecting surfaces 28
7.4 Cleaning surfaces 28

8 Transport and storage conditions 29
8.1 Controller, handpiece with handpiece cable, power supply and foot switch 29
8.2 Needle cartridge 29

9 Disposal 30

10 Questions and problems 30

11 Guarantee 31

12 Declaration of conformity 32

1 ABOUT THIS MANUAL

This operating manual applies to the MESO POWER DEVICE MS-3 (AD12901) and its accessories. It contains important information about setting up, operating and looking after the device safely and as intended for use.

This operating manual is restricted to all information essential for the safe use of the device. For further information, required for the safe use of the device and its accessories, please also read the following additional documentation:

- Safety datasheets for disinfectants and cleaning materials
- Safety at the workplace requirements and statutory provisions for microneedling

1.1 Presentation of warning symbols

Warning symbols highlight the danger to persons or objects and are set up as follows:

 SIGNAL WORD	
Type of danger	
Consequences	
► Prevention	

ELEMENT	MEANING
	Indicates risk of injury
Signal word	Indicates the seriousness of the hazard (see following table)
Type of hazard	the type and source of the hazard
Consequences	describes possible consequences if ignored
Prevention	indicates how the hazard can be prevented

SIGNAL WORD	MEANING
Danger	Indicates a danger which will certainly result in severe or fatal injuries if the danger is not avoided
Warning	Indicates a danger which could result in severe or fatal injuries if the danger is not avoided

SIGNAL WORD	MEANING
Caution	Indicates a danger which may cause slight to medium-severe injuries if the danger is not avoided
Attention	Indicates a potential risk of damage to the environment, property or the equipment if the danger is not avoided

Symbols in this operating manual

SYMBOL	MEANING
▶	Action required
•	Bullet points
-	Sub-bullet points

2 IMPORTANT SAFETY INSTRUCTIONS



2.1 General safety instructions

- ▶ Read this operating manual carefully and in full.
- ▶ Keep this operating manual in a location which is accessible to all those using, cleaning, disinfecting, storing or transporting the device.
- ▶ Always include this operating manual when transferring ownership of the device.
- ▶ Follow the safety regulations for the microneedling in your country. Keep your workplace hygienically clean and ensure that you have adequate lighting.
- ▶ Only use the device, its accessories and all handpiece cables when in perfect condition.
- ▶ Use only original needle cartridges, accessories and spare parts from MT.DERM GmbH.

2.2 Product-specific safety instructions

- ▶ Never modify the device, the needle cartridges or other accessories.
- ▶ Children must be supervised and prevented from playing with the device.
- ▶ Prevent fluids from getting inside the device, the handpiece, the foot switch or the power supply.
- ▶ Avoid sources of interference by ensuring that portable or mobile radio devices are not operated in the vicinity of the device.
- ▶ When being handled, protect the handpiece and the handpiece cable from contamination by bodily fluids or substances contaminated with bodily fluids by means of a handpiece cover (see chapter "5.6 Inserting or replacing the needle cartridge" on page 22).
- ▶ If the device is not being used, disconnect it from the power supply and place the handpiece in the handpiece tray so that it cannot roll away or fall.
- ▶ Observe the technical data provided in this operating manual and comply with the operating, transport and storage conditions (see chapter "8 Transport and storage conditions" on page 29).
- ▶ Send the device to a specialist retailer for inspection if there are signs of damage, if it does not function as normal or if liquids enter the device or handpiece.
- ▶ It is recommended that the device is sent to a specialist retailer for inspection at regular 24 month intervals. In doing so, refer to chapter "7.1 Inspection" on page 27.

2.3 Important health and safety precautions

Please observe the following instructions in order to prevent contaminations or infectious diseases being transmitted to the customers or users during treatment:

- ▶ Follow all of the steps for disinfecting the equipment before treatment (see chapter "5.5 Cleaning and disinfecting the equipment" on page 21).
- ▶ Use disposable gloves made from nitrile or latex during the treatment and disinfect these before use. Observe the applicable directives for your country when selecting suitable disinfectants.
- ▶ Clean the respective area of the customer's skin with a mild cleaning agent and disinfectant before treatment. Observe the applicable directives for your country when selecting suitable disinfectants.
- ▶ If desired for the treatment, use only topical and sterile accompanying preparations that have been tested and approved for insertion into human skin. Observe the applicable directives for your country when selecting these. If substances that are not intended for cosmetic microneedle treatment or whose sterility is not guaranteed, are introduced into the skin, this can result in infections or possible side effects. Observe the accompanying information for the substances used.

- ▶ Use only new, sterile packaged needle cartridges for each customer. Before treatment ensure that the packaging is undamaged and the expiry date has not passed. Note the batch number of the needle cartridge used in the corresponding customer file in order to be able to pass this on to the manufacturer in the event of any problems.
- ▶ needle cartridges are sterile disposable products (consumables) and are only ever permitted to be used once.
- ▶ Dispose of used or faulty needle cartridges as well as needle cartridges whose packaging is damaged in a non-penetrable sharps container in accordance with the regulations applicable in your country.
- ▶ Before the treatment, switch the handpiece off and check that the needles have been completely withdrawn into the needle cartridge. If this is not the case, dispose of the needle cartridge immediately.
- ▶ Ensure that needle cartridges never come into contact with contaminated items, such as clothing for example. Contaminated needle cartridges must not be used but rather disposed of immediately.
- ▶ During use, the handpiece, the handpiece cable and the device including the integrated handpiece tray must be completely covered with protective film. The handpiece must be covered with the protective film sleeve before attaching the needle cartridge (see chapter "5.7 Pulling the handpiece cover on" on page 23).
- ▶ Check at regular intervals whether the handpiece is visibly contaminated by bodily fluids running back or by the pigment ink being used. In this case, observe the contents of chapters "7.4 Cleaning surfaces" on page 28 and "7.2 Material compatibilities" on page 27, as well as the chapter "2.2 Product-specific safety instructions" on page 8.
- ▶ If a local anaesthetic is being used, this should be thoroughly removed before the treatment.
- ▶ Always hold the handpiece firmly before switching it on or place it in the handpiece tray. If an unsecured handpiece is switched on, it may move uncontrollably through vibrations and prick or cause injury (see chapter "6.4 Switching the handpiece on and off" on page 26).

Injuries through contaminated needles or needle cartridges can result in the transmission of diseases (see chapter "5.6 Inserting or replacing the needle cartridge" on page 22). In the event of being injured by a contaminated needle, seek immediate medical attention from a physician!

In order to prevent the intensity of the treatment exceeding the extent desired:

- ▶ Avoid risk of injury due to the needles protruding too deeply (see chapter "6.2 Setting the needle protrusion depth" on page 25).
- ▶ Avoid risk of injury due to the penetration frequency being too high (see chapter "6.3 Setting the penetration frequency" on page 25).

Please be sure to inform your customer to avoid contact with recently treated skin. Recently treated areas of skin should also be protected from

- Contamination and
- UV and solar radiation.

Additional irritants such as

- Visits to swimming pools or saunas
- Abrasive or chemical peelings
- Hair removal at the treated areas or
- Self-tanning products

should be avoided by the customer in the first two to three days after the treatment.

2.4 Contraindications and side effects

The following contraindications and side effects are the results of a thorough analysis of the professional clinical literature concerning microneedle treatment. If the person responsible for the treatment should have the smallest doubt that the safety of the customer being treated cannot be guaranteed, for example due to secondary illnesses or conditions, the treatment should be withheld or stopped immediately.

2.4.1 Contraindications

With the following contraindications, **no** microneedling treatment should be undertaken:

- Haemophilia or other blood-clotting disorders
- Currently taking blood thinning medication (e.g. Warfarin, Heparin, aspirin, acetylsalicylic acid)
- Uncontrolled diabetes mellitus
- Any form of active acne in the area of the treatment
- Dermatitis (e.g. Skin tumours, keloids or extreme tendency for keloid formation, solar keratosis, warts and/or moles) in the area of the treatment
- Open wounds and/or eczema and/or rashes in the area of the treatment
- Scars in the treatment area
- Systemic infections and infectious diseases (e.g. Hepatitis type A, B, C, D, E or F; HIV infection) or acute local skin infections (e.g. herpes, rosacea)
- During chemotherapy, radiotherapy or high-dosage corticosteroid therapy (recommendation: from four weeks before the start until four weeks after the end of the therapy)
- Up to twelve months after a plastic surgery operation in the area to be treated
- Up to six months after filler injections in the area to be treated
- Allergy to topical anaesthetics (local anaesthetic)
- Under the influence of alcohol and/or drugs
- Pregnancy and lactation

The treatment of mucous membrane and eyeballs is strictly forbidden.

The treatment must be immediately aborted in the event of:

- Excessive perception of pain
- Fainting/dizziness

2.4.2 Side effects

Often:

- Localised bleeding in the area of the treated skin
- Pain and discomfort on the first day after the treatment
- Short-term inflammatory reactions, erythema and/or oedema up to six days after the treatment
- Skin irritations (e.g. itching or temperature increase), which normally die out over the first 12 to 72 hours after the treatment
- Formation of scabs, which normally recede in the first five days
- Temporary peeling of the skin which normally subsides within eight days

Seldom:

- Formation of herpes simplex virus type I (HSV-I) blisters
- Formation of small pustules or milia as a result of inadequate cleaning of the skin prior to treatment
- Hyperpigmentation with the body's own pigments, in particular with darker skin types, but completely cleared up within a few weeks
- Inflammatory reactions, haematoma, erythema and oedema
- Retinoid reaction (from slight reddening to peeling of the skin)

As a matter of principle, recently treated skin areas should be protected from UV and solar radiation.

2.5 Required qualification (user requirements)

The device and its accessories may not be used by persons with impaired physical, sensory or mental capabilities or by children. The device and its accessories may not be used by persons with no experience or knowledge unless they are being supervised or instructed (training).

The device may only be used by persons trained in the following:

- Qualification for cosmetic microneedling
- Basic knowledge of microneedling treatment (see chapter "6.3 Setting the penetration frequency" on page 25 and "6.4 Switching the handpiece on and off" on page 26)

- Knowledge of hygiene and safety regulations (see chapter "2.3 Important health and safety precautions" on page 8)
- Knowledge of risks and side effects (see chapter "2.4.1 Contraindications" on page 10 and "2.4.2 Side effects" on page 11)

2.6 Intended purpose, scope of application and proper use

2.6.1 Intended purpose

The device was developed for the cosmetic microneedling (meta therapy) of healthy skin for the purpose of skin rejuvenation. In doing so, the self-regeneration of the skin is stimulated by creating very small punctures in the epidermis (upper skin layer).

With cosmetic microneedling, the epidermis is punctured with minimal invasiveness without the skin incurring open wounds. Afterwards, the skin requires only a very short regeneration phase in which the epithelial function will be restored.

2.6.2 Scope of application

Applications for cosmetic microneedling for increased epidermal penetration are:

- Treatment of lines/wrinkles for skin rejuvenation
- Stimulation of skin cell activity via high-frequency and non-invasive perforation of the epidermis
- Improvement of the blood flow in the skin

2.6.3 Proper intended use

The treatment must be carried out in a dry, clean and smoke-free environment as well as under hygienic conditions. The device must be prepared, used and looked after as described in this operating manual. In particular, the applicable requirements concerning workplace design must be observed and the materials to be used must be sterile.

Intended use also includes the assumption that this operating manual and in particular chapter "2 Important safety instructions" on page 7, have been read in full and understood.



Intended use also assumes the following consumer groups exclusively:















- Adult men and women who are in good health.









Improper use is when the device or its accessories are used in a manner other than as described in this operating manual or if the operating conditions have not been complied with. The treatment of contraindications in particular is forbidden (see chapter "2.4.1 Contraindications" on page 10).

2.7 Symbols on the product

The symbols described below can be found in this operating manual, on the device and on its accessories or the packaging:

SYMBOL	MEANING
	Device complies with the requirements of directive 2006/42/EC & 2004/108/EC
	Attention!
IP21	Housing offers protection from coarse dust and water drops
IPX6	Housing offers protection from jets of water
IP40	Housing offers protection from foreign objects thicker than 1 mm
	Applied part, type B: Applied part provides safety from electrical shock and leakage currents
	Handpiece
	Foot switch
	DC connection, inner pin positive
	DC
	AC
	Observe operating manual!
	Manufacturer
	Date of manufacture
REF	Catalogue number, order number
SN	Serial number

SYMBOL	MEANING
	Batch code
	Sterilised with ethylene oxide
	Can be used until
	Temperature limit
	Humidity limit
	Air pressure limit
	Protect from moisture
	Only use indoors
	Fragile
	Do not use if packaging damaged
	Not for re-use
	Dispose of in compliance with waste electronic appliances guidelines
	Do not re-sterilise
	Warning of cutting or penetrating injuries
	JAPAN TUV R-PSE
	Energy efficiency level VI

SYMBOL	MEANING
	Device complies with Japanese VCCI standards
	CHINA SJ/T 11364-2014
	UL certification for components recognised in Canada and the USA
	Double insulation / device protection class II
	GHOST-R mark for Russia
RoHS2	Device complies with the requirements of RoHS 2
	SIQ mark license EN60601-1
	Ukraine UKRSepro
	See operating manual for further information

3 SCOPE OF DELIVERY

- 1 Controller
- 1 Handpiece
- 1 Handpiece cable
- 1 Power supply
- 1 country-specific adapter (EU)
- 1 Foot switch
- 1 German operating manual
- 1 English operating manual

The needle cartridges and handpiece covers (E-0610) required for operation are not included in the delivery. Suitable accessory parts for the handpiece can be obtained via specialist retailers, see "4.3 Accessories and spare parts" on page 16.

4 PRODUCT INFORMATION

4.1 Technical data

Device type	AD12901
Nominal voltage	15 V DC
Power consumption	max. 7 VA
Power supply model	Model number: GTM96180-1817.9-2.9 Part number: WR9QG1200CSPCR6B2958 (GlobTek)
Protection class	2
Penetration frequency	50-150 Hz
Drive	Precision motor - DC
Operating mode	Continuous operation
Dimensions (W x H x D)	230 mm x 45 mm x 185 mm
Handpiece weight	approx. 80 g
Total weight	approx. 1100 g

4.2 Operating conditions

Ambient temperature	+10 °C to +35 °C
Relative humidity	30% to 75%
Air pressure	700 hPa to 1070 hPa

4.3 Accessories and spare parts

The following accessories and spare parts can be purchased from authorised retailers.

ACCESSORIES	ARTICLE DESCRIPTION	SCOPE OF DELIVERY	PIECE/VPE
Needle cartridges	E-MM0002 (OND P 0.5 C VYTAL)	–	15
	E-MM0006 (OND M 0.7 C VYTAL)	–	15
Handpiece cover	E-0610	–	16

SPARE PART	ARTICLE DESCRIPTION	SCOPE OF DELIVERY	PIECE/VPE
Controller	MAD12901	1	1
Handpiece	CMN50	1	1
Foot switch	E-1010	1	1
Handpiece tray	FG-AD1.0-1	1	1
Power supply	E1165	1	1
Country-specific adapter	EU: E-1154	1	1
Operating manual	7EAD12901EN	1	1
	7EAD12901DE	1	1

5 GETTING STARTED



CAUTION

Cable tripping hazard

An incorrectly laid cable can constitute a tripping hazard and cause injury.

- ▶ Ensure all cables are positioned so that no one can trip over them or pull on them unintentionally.



CAUTION

Danger of injury and of device malfunctions

Unsuitable accessories and spare parts can impair the function and safety of the device. The device can be damaged or can fail or malfunction endangering persons.

- ▶ Use only the needle cartridges, accessories and spare parts listed in chapter "4.3 Accessories and spare parts" on page 16.

ATTENTION

Danger of short-circuit

There is a risk of damage to electronics if there is visible damage to cables or cable connections.

- ▶ Check the device and the cables by visually checking for damage such as a defective cable connection for example.
- ▶ Never kink the product's cable.

ATTENTION

Damage from condensate

If the device is exposed to high temperature variations e.g. during transport, condensate may accumulate inside and damage the electronics.

- ▶ Ensure that the device has reached ambient temperature before using it. If the device has been exposed to high temperature variations, wait for at least 3 hours per 10 °C of temperature difference before using it.

5.1 Positioning the device



CAUTION

Reduced functionality due to electromagnetic interference

Portable and mobile HF communications devices, such as mobile phones or WLAN routers, can influence the functionality of the device through the transmission of electromagnetic radiation. Safe operation of the device can no longer be assured.

- ▶ Avoid sources of interference by ensuring that portable or mobile radio devices are not operated in the vicinity of the device.
- ▶ Inform your customers about the risk of sources of interference.

ATTENTION

Damage to the device due to inadequate stability

If the device is not positioned safely, safe operation is not guaranteed. The device could fall and get damaged during operation.

- ▶ Place the device on a clean, firm and level surface.
- ▶ Ensure that the buttons and the display of the device remain freely accessible during use.
- ▶ Never place the device on or underneath other devices.

- ▶ Place the device on a clean, firm and level surface.

5.2 Connecting the power supply

The device may only be operated with the power supply cited on the type plate of the device. The mains voltage must match with the device voltage cited on the label of the power supply.

- ▶ If there is no suitable country-specific adapter included in the scope of delivery, contact an authorised dealer (see also chapter "10 Questions and problems" on page 30).

To remove the existing country-specific adapter, if necessary:

- ▶ Pull back and hold the catch for the adapter and at the same time lift the country-specific adapter out of the recess in the power supply.

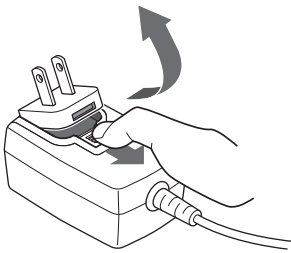

Fig. 1: Remove country-specific adapter

To insert the desired country-specific adapter:

- ▶ Place the country-specific adapter in the recess of the power supply as shown below.

- ▶ Press the adapter into the plug-in power unit until the catch can be heard to engage.

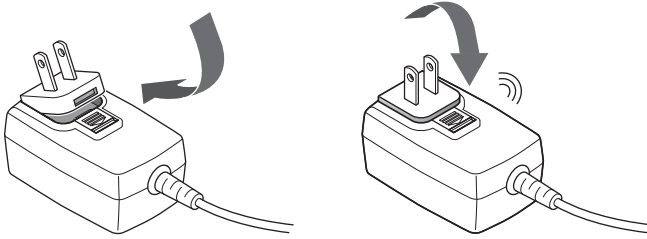

Fig. 2: Inserting country-specific adapter

In order to establish the power supply:

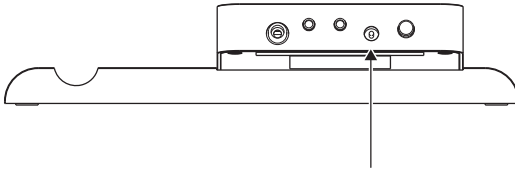

Fig. 3: Socket for the power supply

- ▶ Insert the power supply into a mains outlet.
The standby LED on the controller illuminates white.

5.3 Connecting the foot switch (optional)

Only the foot switch cited in chapter "4.3 Accessories and spare parts" on page 16 will ensure safe operation.

- ▶ Insert the RCA plug of the foot switch into the socket for the foot switch (⤴) on the rear of the controller.

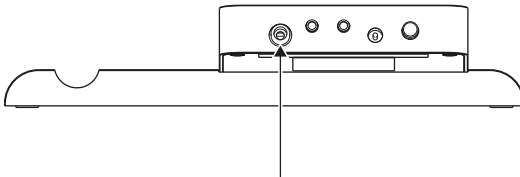

Fig. 4: Socket for the foot switch

5.4 Connecting the handpiece

- ▶ Connect the FireWire jack plug of the handpiece cable to the socket on the controller.

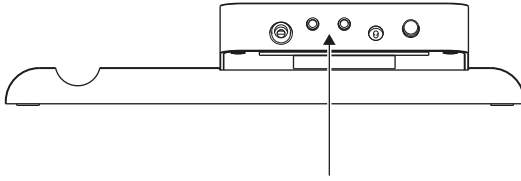

Fig. 5: Output socket

5.5 Cleaning and disinfecting the equipment

ATTENTION

Damage due to fluids

If cleaning products or disinfectant gets inside the handpiece, the controller or the power supply, this may cause a short-circuit. In addition, this may also corrode the electrical and mechanical components.

- ▶ Never immerse the handpiece, the controller or the power supply in cleaning product or disinfectant.
- ▶ Never clean the handpiece, the controller or the power supply in autoclaves or in an ultrasonic cleaning bath.
- ▶ Consider material compatibilities when selecting cleaning materials and disinfectants (see chapter "7.2 Material compatibilities" on page 27).

ATTENTION

Device damage caused by unapproved cleaning materials or disinfectants

Cleaning materials or disinfectants that are not compatible with the materials of the device can cause damage to its surface.

- ▶ Use only cleaning materials and disinfectants that are authorised for use by the legislation in your country.
 - ▶ Consider material compatibilities when selecting cleaning materials and disinfectants (see chapter "7.2 Material compatibilities" on page 27).
-
- ▶ Disconnect the controller from the power supply.
 - ▶ Wipe the controller, the handpiece cable, the handpiece and the handpiece tray with a soft cloth moistened with cleaning product.

- ▶ Wipe the handpiece, the controller, the handpiece cable and the handpiece tray with a soft cloth moistened with disinfectant.

5.6 Inserting or replacing the needle cartridge



WARNING

Danger of injury due to needles

Injuries through contaminated needles can result in the transmission of diseases.

- ▶ Use exclusively original needle cartridges, appropriate to the handpiece supplied, for the device. The safety membrane installed in these needle cartridges prevents bodily fluids entering the drive and pathogens are also unable to pass the membrane.
- ▶ Never touch the points of the needle cartridge.
- ▶ Switch the handpiece off before replacing the needle cartridge.
- ▶ Never press the needles out of the needle cartridge.
- ▶ When removing a needle cartridge, ensure that any ink or accompanying preparations that may be being used do not run from the needle cartridge into the handpiece.
- ▶ After removing the used needle cartridge, check that the needles have been completely withdrawn into the cartridge.
- ▶ Dispose of used needle cartridges that are no longer required for the current treatment properly (see chapter "9 Disposal" on page 30).
- ▶ The needle cartridges are shipped in sterile packaging. Only remove them from the sterile packaging immediately before use. To do so, open the sterile packaging of the needle cartridge at the PEEL marking (▼)
- ▶ Always place the handpiece back in the handpiece tray so that the needle cartridge does not rest on the surface.
- ▶ In the event of being injured by a contaminated needle, seek medical attention from a physician.

- ▶ Switch the handpiece off.

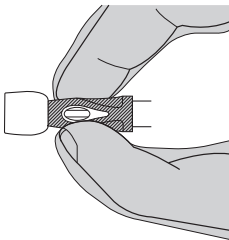

Fig. 6: Holding the needle cartridge

- ▶ Grasp the needle cartridge by the base body to insert it in the handpiece.
- ▶ Place the bayonet fastening of the needle cartridge in the opening in the handpiece. You can insert the safety cartridge with all possible orientations.

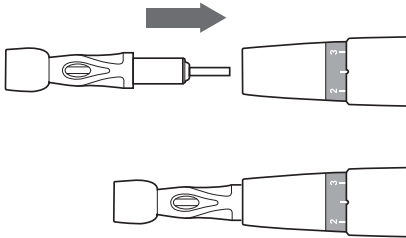

Fig. 7: Inserting the needle cartridge

- ▶ Turn the needle cartridge clockwise until you can feel resistance. The needle cartridge is now firmly seated in the handpiece.

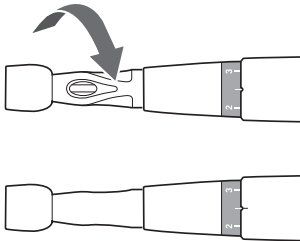

Fig. 8: Tightening the needle cartridge

- ▶ Check that the needle cartridge is firmly seated.
- ▶ To remove the needle cartridge, turn it anticlockwise and remove it from the handpiece.

5.7 Pulling the handpiece cover on

We recommend using the handpiece covers provided as accessories. Alternatively, you can use equivalent handpiece covers with a diameter of 20 to 27 mm. This represents a sleeve width of approx. 30 to 45 mm.

In order to protect the handpiece and the handpiece cable from contamination with bodily fluids or accompanying preparations contaminated with bodily fluids during the treatment:

- ▶ Unplug the handpiece cable from the handpiece.
- ▶ Slide the handpiece cover fully over the handpiece cable.
- ▶ Connect the handpiece cable, with the handpiece cover fitted on it, to the handpiece connection once more.
- ▶ Draw the end of the handpiece cover fully over the handpiece.

- ▶ Stick the end of the handpiece cover firmly to the moving part of the handpiece.

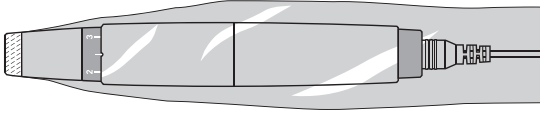

Fig. 9: Handpiece cover in place

- ▶ Dispose of the used hygiene sleeves in containers for proper disposal of contaminated parts, after the conclusion of each treatment.

5.8 Checking equipment

- ▶ Carry out a visual check of the equipment:
 - Are there any signs of external damage (e.g. kinks in the handpiece cable, detached cap in the area of the cable connection)?
 - Are any cables disconnected?
 - Are the needle cartridge and needles aligned correctly? Are all needles fully withdrawn into the needle cartridge ?
- ▶ Switch the handpiece on and carry out an acoustic check: Are operating noises or sounds prominent?
- ▶ In the event of anomalies, refer to chapters "10 Questions and problems" on page 30 and "11 Guarantee" on page 31.
- ▶ If the device can no longer be operated harmlessly, take it out of service and contact an authorised dealer.

6 USE

6.1 Switching the control unit to operating mode or standby mode

To switch the controller to operating mode:

- ▶ Ensure that the power supply is established (see chapter "5.2 Connecting the power supply" on page 19).

The **Power** LED indicator (⊕) illuminates white.

The controller is in standby mode.

- ▶ Switch the controller on with the **Device ON/OFF** button on the rear of the controller. The **Device ON/OFF** button latches in.

A short signal tone can be heard.

The corresponding LED on the **Select handpiece I/II** buttons illuminates white.

The preset penetration frequency (100 Hz) appears on the display.

To switch the controller to standby mode:

- ▶ Press the **Device ON/OFF** button on the rear of the controller.

6.2 Setting the needle protrusion depth



CAUTION

Risk of injury due to excessive needle protrusion

A large needle protrusion depth allows a greater penetration depth. If the needle protrusion depth and the penetration depth are too great, the risk of side effects, such as haematoma, erythema or oedema, as well as their potential severity increases (see chapter "2.4.2 Side effects" on page 11).

- ▶ Select the needle protrusion depth on the basis of the skin characteristics of the client and the skin area to be treated.

The moving part of the handpiece is labelled with a scale, which indicates the needle protrusion depth setting.

- ▶ Switch the handpiece on.
- ▶ Set the needle protrusion depth by turning the moving part of the handpiece (1). Use the scale as a guide and turn it until the marker (2) is at the desired position. Turning it clockwise (when looking at the needles) increases the needle protrusion depth.

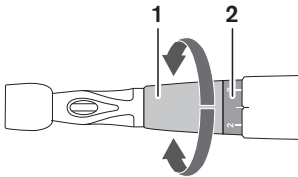

Fig. 10: Setting the needle protrusion depth

6.3 Setting the penetration frequency



CAUTION

Risk of injury due to high puncture frequency

If the puncture frequency is too high, the skin can be cut open.

- ▶ Select the penetration frequency on the basis of the skin characteristics and suitable for the working speed.

The preset puncture frequency amounts to 100 punctures per second. The controller automatically resets to this preset every time it is switched on. The device has a puncture frequency range of 50-150 punctures per second and can be adjusted in 10 steps.

The number of penetrations per second shown on the display may deviate by $\pm 10\%$ in stationary operation from the value that actually occurs at the handpiece.

To set a suitable penetration frequency:

- ▶ Ensure that the controller is switched on (see chapter "6.1 Switching the control unit to operating mode or standby mode" on page 24).
- ▶ Press the **Increase frequency** button (\wedge) to increase the penetration frequency.
- ▶ Press the **Decrease frequency** button (\vee) to decrease the penetration frequency.

6.4 Switching the handpiece on and off



CAUTION

Danger of injury when using the handpiece

If an unsecured handpiece is switched on, it may move uncontrollably through vibrations and cause injury.

- ▶ Hold the handpiece firmly before switching it on or place it in the handpiece tray.

To switch on the handpiece:

- ▶ Ensure that the power supply is established (see chapter "5.2 Connecting the power supply" on page 19).
- ▶ Ensure that the controller is switched on (see chapter "6.1 Switching the control unit to operating mode or standby mode" on page 24).
- ▶ Ensure that the handpiece is correctly connected (see chapter "5.4 Connecting the handpiece" on page 21).
- ▶ Press the **Treatment ON/OFF** button on the controller.

If the connected handpiece does not start:

- ▶ Observe the chapter "10 Questions and problems" on page 30.

To switch off the handpiece:

- ▶ Press the **Treatment ON/OFF** button again.

7 CLEANING AND MAINTENANCE

ATTENTION

Danger of short-circuit

There is a risk of damage to electronics if device components are dismantled and cleaned whilst still electrically connected.

- ▶ Disconnect the controller from the power supply before any cleaning or maintenance tasks.

ATTENTION

Damage due to fluids

If cleaning products or disinfectant gets inside the handpiece, the controller or the power supply, this may cause a short-circuit. In addition, this may also corrode the electrical and mechanical components.

- ▶ Never immerse the handpiece, the controller or the power supply in cleaning product or disinfectant.
- ▶ Never clean the handpiece, the controller or the power supply in autoclaves or in an ultrasonic cleaning bath.
- ▶ Consider material compatibilities when selecting cleaning materials and disinfectants (see chapter "7.2 Material compatibilities" on page 27).

7.1 Inspection

Inspections may only be carried out by authorised dealers.

It is recommended that the device is handed over to a specialist retailer for inspection in accordance with manufacturers instructions, at regular 24 month intervals.

7.2 Material compatibilities

- ▶ To clean the device, use a mild soap detergent authorised in your country, or 50% diluted 1-propanol solution.
- ▶ Use the following disinfectants to disinfect the device:

MANUFACTURER	PRODUCT	WORKING-IN TIME
Antiseptica	Big Spray "new"	1 to 5 min
Bode Chemie	Bacillol	30 s to 1 min

MANUFACTURER	PRODUCT	WORKING-IN TIME
Ecolab	Incidin Foam	1 to 2 min
Schülke & Mayr	Mikrozid Liquid	1 to 2 min

Based on the following material compatibilities, you can assess which cleaning products and disinfectants are suitable.

The device surfaces are **resistant** to:

- Mild acids (e.g. boric acid $\leq 10\%$, acetic acid $\leq 10\%$, citric acid $\leq 10\%$)
- Aliphatic hydrocarbons (e.g. pentane, hexane)
- Ethanol
- Most inorganic salts and their aqueous solutions (e.g. sodium chloride, calcium chloride, magnesium sulphate)

The device surfaces are **not resistant** to:

- Strong acids (e.g. hydrochloric acid $\geq 20\%$, sulphuric acid $\geq 50\%$, nitric acid $\geq 15\%$)
- Oxidising acids (e.g. peracetic acids)
- Lyes (e.g. caustic soda, ammonia and all compounds with $\text{pH} > 7$)
- Aromatic/halogenated hydrocarbons (e.g. phenol, chloroform)
- Acetone and petrol

7.3 Disinfecting surfaces

Before and after each use:

- ▶ Disinfect the handpiece cable, the handpiece and the handpiece tray as described in chapter "5.5 Cleaning and disinfecting the equipment" on page 21.

7.4 Cleaning surfaces

External soiling:

- ▶ Wipe the device and its accessories with a soft cloth moistened in the cleaning product or disinfectant.

8 TRANSPORT AND STORAGE CONDITIONS

8.1 Controller, handpiece with handpiece cable, power supply and foot switch

ATTENTION

Damage due to dropping

If the controller or the handpiece is dropped it can be damaged.

- ▶ Always set the controller down on the rubber feet on a flat and stable surface so that it cannot fall.
- ▶ Place the handpiece back in the handpiece tray after each use so that it is safe.
- ▶ If the controller or the handpiece is dropped, carry out a visual check of the components.
- ▶ Hand the controller or the handpiece in to an authorised dealer if the components have visible damage or if they no longer function normally.

- ▶ Transport the device and its accessories only in the original packaging.
- ▶ Store the device and its accessories only in the following conditions:

Ambient temperature	-10 °C to +40 °C
Relative humidity	10% to 90%
Air pressure	540 hPa to 1070 hPa

8.2 Needle cartridge

- ▶ Always store the needle cartridges in the following conditions:

Ambient temperature	+15 °C to +25 °C
Relative humidity	30% to 65%

9 DISPOSAL

- ▶  Dispose the products showing this symbol in compliance with applicable regulations on the disposal of electronic waste. If necessary, ask your specialist retailer or competent authorities about the applicable regulations.
- ▶ Place a container at your workplace for the proper disposal of contaminated parts.
- ▶ Dispose used or faulty needle cartridges as well as needle cartridges whose packaging is damaged in a suitable sharps container. Follow the local guidelines for the disposal of the sharps containers

10 QUESTIONS AND PROBLEMS

The following functional disruptions or fault messages could occur:

FAULT/ MESSAGE	FAULT	CAUSE	RECTIFICATION
The controller will not switch to standby mode.	The power supply is disconnected.	The power supply is not correctly connected.	<ul style="list-style-type: none"> ▶ Check the connection of the power supply to the controller (see chapter "5.2 Connecting the power supply" on page 19). ▶ Check the power supply of the work station.
The controller switches off automatically during operation.	The power supply is disconnected or there is a fault in the controller.	The power supply is not correctly connected.	<ul style="list-style-type: none"> ▶ Check the connection of the power supply to the controller (see chapter "5.2 Connecting the power supply" on page 19). ▶ Check the power supply of the work station.

In order to rectify further functional disruptions:

- ▶ Firstly, disconnect all components, such as the handpiece and the power supply, from the controller.
- ▶ Check all connections and reconnect the components.
- ▶ Check the function of the device again.
- ▶ If malfunctions persist or if you have any questions or complaints, please contact your specialist retailer.

11 GUARANTEE

This device is a high-quality purchase.

The product is covered by the statutory 2-year warranty against malfunctions due to material failure or production defects.

We guarantee the sterility of the needle cartridge until the use-by date on the needle cartridge packaging providing that the packaging is sealed and undamaged and that the transport and storage conditions have been complied with. In the event of complaints relating to needle cartridges, please provide us with the batch number printed on the label.

The warranty does not apply to the following damage:

- Damage and consequential damage caused by improper use or failure to comply with the operating manual.
- Damage caused by the ingress of fluids or dirt into the inside of the handpiece, the controller or the power supply.

12 DECLARATION OF CONFORMITY

The manufacturer MT.DERM GmbH
Gustav-Krone-Str. 3
D-14167 Berlin

Hereby declares under their own responsibility that the following product:

Product: Micro-needling system
Product name: MESO POWER DEVICE MS-3
Article description: AD12901

Complies with the following directives:

EMC directive: 2014/30/EU
Machinery directive: 2006/42/EU
RoHS directive: 2011/65/EU

The following harmonised standards have been applied:

DIN EN 60335-1:2012-10 Safety of electronic devices for domestic use and similar purposes – Part 1: General requirements
DIN EN 55014-1:2012-05 EMC requirements for household devices, electrical tools and similar electrical appliances – Part 1: Radiated interference
DIN EN 55014-2:2016-01 EMC requirements for household devices, electrical tools and similar electrical appliances – Part 2: Immunity from interference
DIN EN 62233:2008-11 Procedure for measuring the electromagnetic fields from household devices and similar electrical appliances with regard to the safety of persons in electromagnetic fields
DIN EN 1037:2008-11 Safety of machinery – prevention of unexpected start-up
DIN EN ISO 14971:2013-04 Medical products – application of risk management to medical products

Person authorised to compile the relevant technical documents:

Dr. Andreas Pachten, MT.DERM GmbH, documentation officer

This declaration is made with the authorisation of the manufacturer by:

Berlin, 12/12/2018, Jörn Kluge



(Signature of the managing director or their authorised representative)

Original







Manufactured by:

MT.DERM

MT.DERM GmbH | Gustav-Krone-Str. 3 | 14167 Berlin
fon +49 (0)30 845 88 54 | fax +49 (0)30 84 58 85 55 | info@mtderm.de | mtderm.de